

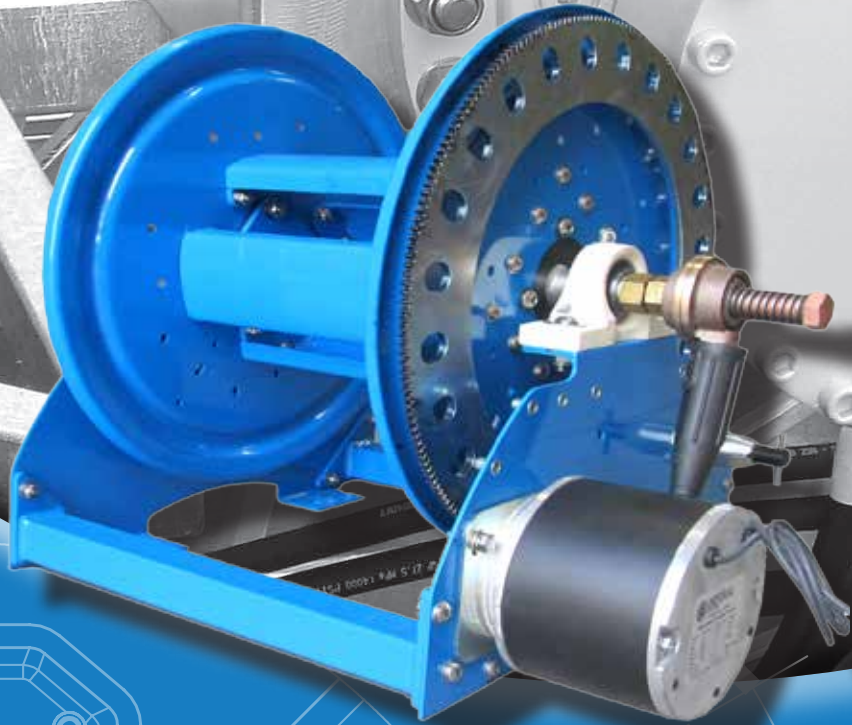

ReCoila

HOSE AND CORD REELS

WELDING REELS



30°



HOSE REELS.

Our total, dedicated business.

We've been making hose reels for decades - over 38 years in fact - and this manufacturing wisdom, coupled with competitive pricing, knowledgeable staff, a wealth of technical information and solid after-sales service positions us firmly at the forefront of our industry.

Our head office and factory is based in Sydney Australia, with a well-stocked distribution centre in Auckland NZ, as well as reputable distribution partners across the globe.

ReCoila has a fully equipped production facility and a team of experts to ensure our reels are designed and manufactured to exacting standards.

With a comprehensive range of hose, cord and cable reels and a dedicated custom design and manufacturing team, ReCoila can supply the right reel for your individual application - with safety and productivity in mind.

AUSTRALIAN MANUFACTURING. INTERNATIONAL DISTRIBUTION.

ReCoila is a proudly Australian company based in Western Sydney, with distribution reach across Australia, New Zealand and internationally.

We have resellers strategically based in key metro and regional areas to ensure delivery to customers is as swift as possible, and long standing relationships with our freight carriers mean that logistics are coordinated efficiently.

AUSTRALIAN MADE + QUALITY IMPORTS = COMPREHENSIVE RANGE.

Our range constitutes a wealth of engineered polypropylene and heavy duty steel and stainless steel reels, supplemented with hand-picked reels from some of the world's best manufacturers, to present a truly comprehensive product portfolio. And, our ability to design and manufacture customised reels in-house means that we're sure to have a reel to suit your needs.



VISIT
RECOILA
ONLINE



SPECIALISTS IN CUSTOM REELS

38+ years manufacturing wisdom

ReCoila is committed to continued quality and engineering excellence, coupled with real-world practicality and constant improvement based on feedback from customers.

Our goal has always been to design the best reels in the world - and we think we're pretty close to the mark.

With teams of specialists for both steel and polypropylene production, we continue to lead the way in design, innovation, functionality & reliability.

WE KNOW REELS – YOU KNOW YOUR BUSINESS.

Whilst we've been building reels for over thirty years, we continue to learn and adapt to individual industry challenges in consultation with our customers.

We have worked with Australian and New Zealand fire brigades, Australian Defence forces, major international mining and resources projects, salmon farms, airports, oil rigs, gas exploration companies, plumbers, truck builders, food manufacturers, wineries, auto workshops, universities and electricity providers, and have built reels to transfer everything from clean air to cow dung.

Our collaborative approach has always resulted in a hose reel that is of the highest quality, whilst being simple, practical and effective for the people in the field who are actually operating it.

THE MAKING OF A CUSTOM HOSE REEL



WELDING REELS

Tougher, safer, more reliable

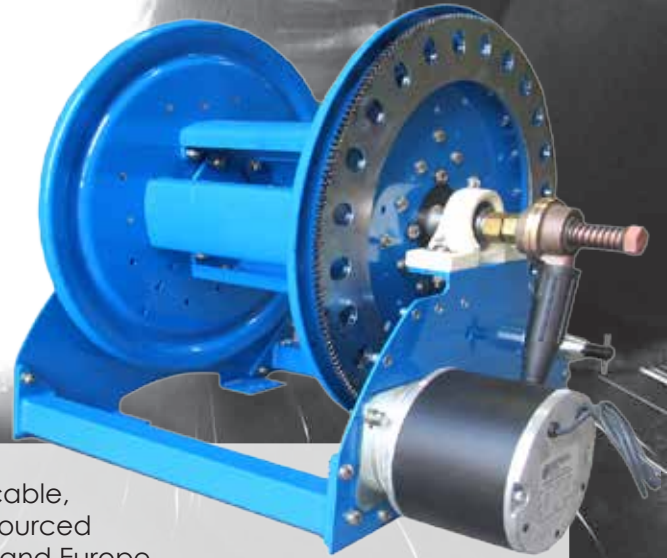

ReCoila's range of electrical cable, welding cable, twin hydraulic and static discharge reels are sourced from the most respected manufacturers in US and Europe, resulting in a world-class range of welding, cutting, power and hydraulic solutions.

As Australia's only authorised Reelcraft agent, we can bring you a wealth of hose reels suited to processes such as welding, cutting and grounding.

And with our locally made C Series welding reels completing the range, ReCoila can supply the perfect reel for your needs.

C SERIES WELDING CABLE REELS

APPLICATION

The C Series welding reels have all the features of our rugged Australian made C Series range. A 3mm steel plate construction and choice of hand crank rewind, or electric, hydraulic or pneumatic motors means you can choose the perfect reel for your needs.



EWC480300
RIGHT HAND VERSION

CABLE TYPE	Supplied with or without cable
MEDIA	Welding cable
CONSTRUCTION MATERIAL	Steel
FINISH	Powder Coated

FEATURES



DIMENSIONS

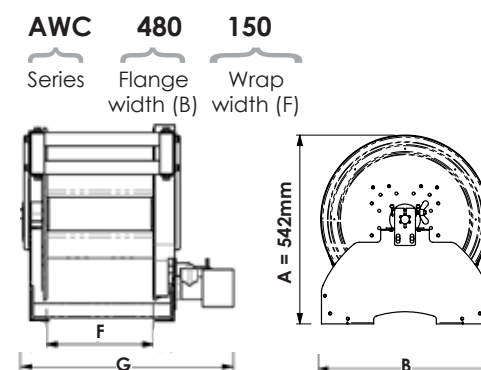

Detailed dimensional drawings available on request.
Quote drawing number ST11093-A.1

C SERIES WELDING CABLE REELS

Model	Drive Type	Cable Capacity (length in metres x cable mm ²)			Reel Overall Width in mm (G)
WC480150	Hand crank	90m x 35mm ²	60m x 50mm ²	55m x 70mm ² cable	505
WC480300	Hand crank	180m x 35mm ²	120m x 50mm ²	110m x 70mm ² cable	655
WC480450	Hand crank	300m x 35mm ²	190m x 50mm ²	160m x 70mm ² cable	805
AWC480150	Air drive	90m x 35mm ²	60m x 50mm ²	55m x 70mm ² cable	370
AWC480300	Air drive	180m x 35mm ²	120m x 50mm ²	110m x 70mm ² cable	520
AWC480450	Air drive	300m x 35mm ²	190m x 50mm ²	160m x 70mm ² cable	670
EWC480150	12VDC Electric drive	90m x 35mm ²	60m x 50mm ²	55m x 70mm ² cable	385
EWC480300	12VDC Electric drive	180m x 35mm ²	120m x 50mm ²	110m x 70mm ² cable	536
EWC480450	12VDC Electric drive	300m x 35mm ²	190m x 50mm ²	160m x 70mm ² cable	686
EAWC480150	24VDC Electric drive	90m x 35mm ²	60m x 50mm ²	55m x 70mm ² cable	385
EAWC480300	24VDC Electric drive	180m x 35mm ²	120m x 50mm ²	110m x 70mm ² cable	536
EAWC480450	24VDC Electric drive	300m x 35mm ²	190m x 50mm ²	160m x 70mm ² cable	686
HWC480150	Hydraulic drive	90m x 35mm ²	60m x 50mm ²	55m x 70mm ² cable	370
HWC480300	Hydraulic drive	180m x 35mm ²	120m x 50mm ²	110m x 70mm ² cable	520
HWC480450	Hydraulic drive	300m x 35mm ²	190m x 50mm ²	160m x 70mm ² cable	670

WC SERIES WELDING CABLE REELS

APPLICATION

The WC Series reels are designed to increase safety in the work area by storing work lead or electrode lead, up to #2/0, safely and effectively when not in use. Each lead requires a separate reel. For indoor use only.

CABLE TYPE	Supplied with or without cable
MEDIA	Welding cable
CONSTRUCTION MATERIAL	Steel
FINISH	Painted
FITTING TYPE	Not supplied

FEATURES



WC 80001 106
SHOWN WITH CABLE

DIMENSIONS

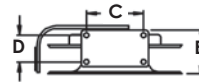
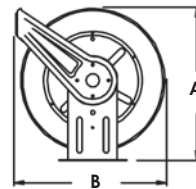

	WC7000	WC80000
A	512	645
B	483	610
C	200	254
D	98	152
E	362	406

WC SERIES INDOOR WELDING CABLE REELS

Model	Reel capacity (m)			Weight (kg)
	#1 (39mm ²)	#1/0 (50mm ²)	#2/0 (62mm ²)	
WC 7000 106	15	15	15	22
WC 80001 106	22	22	22	36
WC 80002 106	30	-	-	37

TW & BA SERIES WELDING & CUTTING BARE REELS

APPLICATION

The TW Series dual inlet reels combine practical engineering with highest quality manufacturing techniques to provide reliable performance. These reels are suited to oxygen, oxygen & acetylene, and propane.

The TW Series twin welding reels are designed with a heavy gauge steel frame, full flow swivels, double sealed O-rings and a spring driven rewind system, resulting in a safer solution for welding hoses in the workplace. The TW Series reels have a spring rewind system whilst the BA Series reels are hand crank.



TW86000 OLPT 106
SHOWN WITH HOSE

HOSE TYPE	Supplied with or without hose
MEDIA	Welding gases
MAX PRESSURE	300psi
CONSTRUCTION MATERIAL	Steel
FINISH	Painted
FITTING TYPE	5/8 UNF inlet fitting

DIMENSIONS

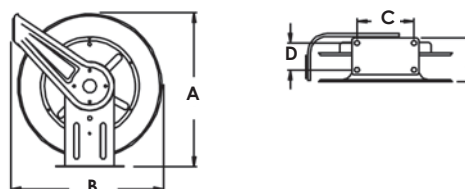



	TW5000	TW7000	BA36106	BA36112	TW80000
A	368	514	524	524	645
B	349	483	451	451	610
C	248	200	229	229	254
D	64	98	248	400	152
E	152	178	423	575	330

FEATURES



TW SERIES WELDING & CUTTING BARE REELS

Model	Hose ID Capacity (mm)	Hose Length Capacity (m)	Weight (kg)
TW5400 OLP 106	Twin 6mm	8	9
TW7400 OLP 106	Twin 6mm	18	19
TW84000 OLP 106	Twin 6mm	30	36
 TW86000 OLP 106	Twin 10mm	23	39
BA36106 LT 106	Twin 6mm	38	22
BA36112 LT 106	Twin 6mm	76	25

 = Quick Ship Item, see inside back cover for more information.

STAY IN TOUCH

News and updates



RECOILA ON LINKED IN
[linkedin.com/company/
recoila-hose-and-cord-reels](https://linkedin.com/company/recoila-hose-and-cord-reels)



JOIN OUR MAILING LIST
Visit recoila.com.au and click
GET UPDATES in the main menu



LIKE US ON FACEBOOK
facebook.com/Recoila



VISIT OUR WEBSITE
recoila.com.au

LEARN MORE



RECOILA AUSTRALIA - HEAD OFFICE
Unit 1/10 Melissa Place
Kings Park NSW 2148
Australia

Phone +61 2 9621 8988
Fax +61 2 9621 7688
sales@recoila.com.au

RECOILA NEW ZEALAND
18 Maui Street, Pukete
Hamilton 3200
New Zealand

Phone +64 7 847 4111
Fax +64 7 847 4112
sales@recoila.co.nz

www.recoila.com.au

www.recoila.co.nz

VISIT
RECOILA
ONLINE

